

Dimensions con't

Accessories

LW9Z-BM
Metallic Mounting Hole Plug

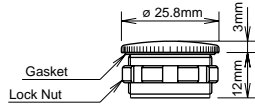

OB-31
Rubber Mounting Hole Plug

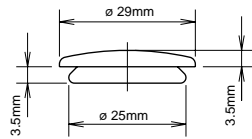

HW9Z-RL
Anti-Rotation Ring

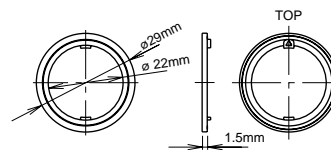

OR-55
Lamp/LED Removal Tool

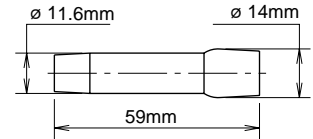

HW9Z-KL1
Padlock Cover

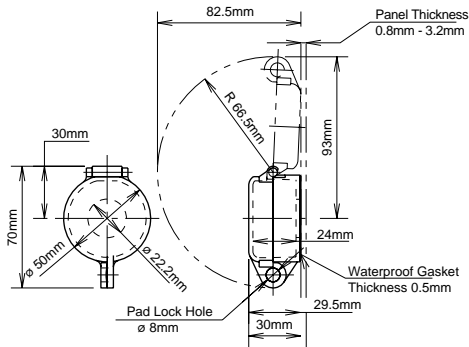

HW-VL1
Barrier

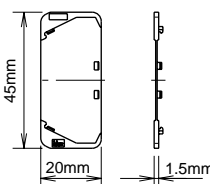

Mounting Hole Layout

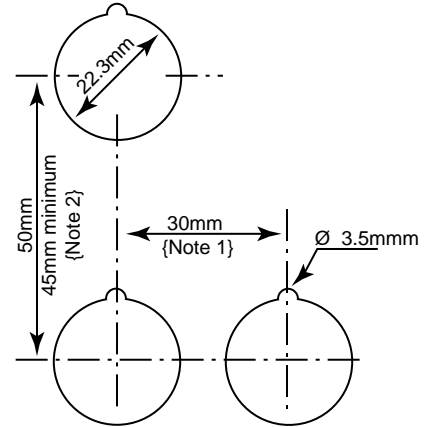

HWLS-TK1971
Safety Lever Lock

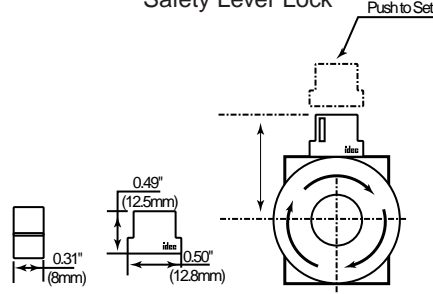

Note 1: Mushroom Button 40mm Type: 40mm or more

Note 2: Pilot Light: 30mm minimum

The values represent the minimum mounting centers when one stack of contact blocks is used. When two stacks or an illuminated unit is used, refer to the dimensions and consider wiring accessibility to determine minimum mounting centers.

HW9Z-KG1-TK2120

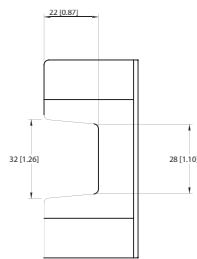
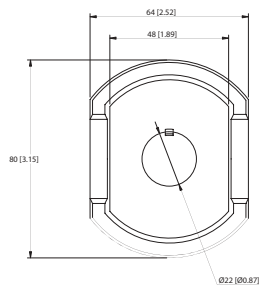

HW9Z-KG2-TK2120

